

# FRETURE

EMISSION FREE PROCESS

PROCESS AUTOMATION & CONTROL

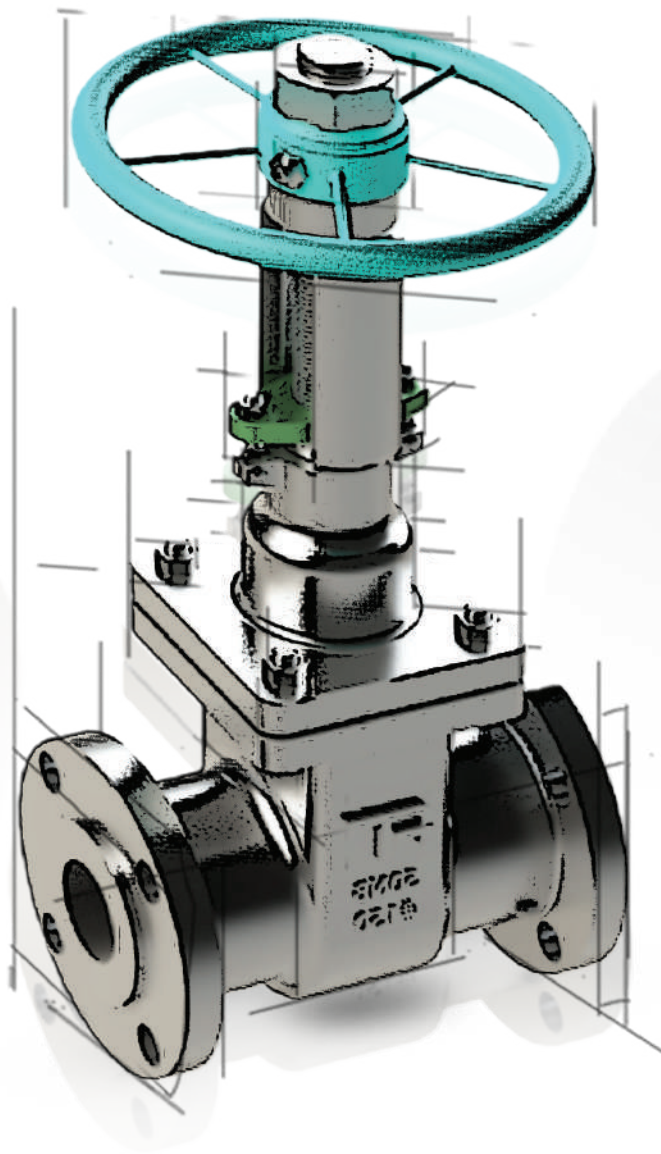

INNOVATION FOR SUSTAINABILITY

## GATE VALVE

[www.freture.com](http://www.freture.com)

ISO 9001 - 15000 | ISO 14000 | ISO 45001 | PED 2014 / 68 / EU | IBR

## API GATE VALVE

Design : DIN 3352 / API 6D / API 600

Operation : Manual & Actuated (Diaphragm / Electric / Gear / Cylindrical)

End Connection	Size	Class
Flanged / Butt Weld	15NB- 600NB	150#- 1500#

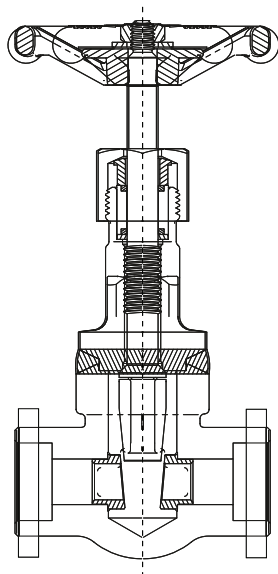
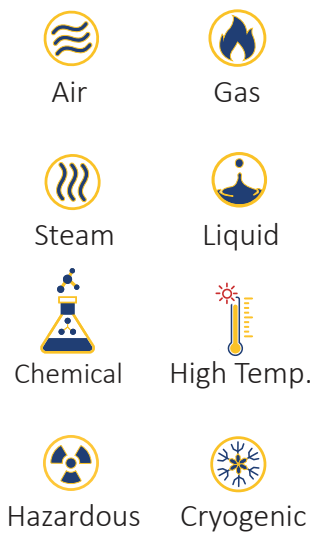









Description	Carbon Steel	Carbon Steel	Alloy Steel	Stainless Steel
Body	A 216 Gr. WCB	A 352 Gr. LCB	A 217 Gr. C5	A 351 Gr. CF8M
Bonnet	A 216 Gr. WCB	A 352 Gr. LCB	A 217 Gr. C5	A 351 Gr. CF8M
Wedge	A 216 Gr. WCB + Stellite	A 352 Gr.e LCB + Stellite	A 217 Gr. C5 + Stellite	A 351 Gr. CF8M + Stellite
Yoke	A 216 Gr. WCB	A 352 Gr. LCB	A 217 Gr. C5	A 351 Gr. CF8M
Stem	A 182 Gr. F6a	A 182 Gr. F304	A 182 Gr. F6a	A 182 Gr. F316
Seat Ring	A 105 + Stellite	A 182 Gr. F304 + Stellite	A 182 Gr. F6a + Stellite	A 182 Gr. F316 + Stellite
Stem Nut	B 148 / A 439 Gr	B 148 / A 439 Gr	B 148 / A 439 Gr	B 148 / A 439 Gr
Backseat	Stellite	Stellite	Stellite	Stellite
Gland	A 105	A 105	A 182 Gr. F6a	A 182 Gr. F316
Gland Flange	A 105	A 105	A 105	A 182 Gr. F304
Stem Packing	Graphite	Graphite	Graphite	Graphite
Gasket (Class 900)	Graphite or SS304L	Graphite or SS304L	Graphite or SS304L	Graphite or SS316L
Gasket (Class 1500)	Graphite or SS304L	Graphite or SS304L	Graphite or SS304L	Graphite or SS316L
Gasket (Class 2500)	Graphite or SS304L	Graphite or SS304L	Graphite or SS304L	Graphite or SS316L
Bonnet Bolt & Nut	A 193 Gr. B7 / A 194 Gr. 2H	A320 Gr. L7 / A194 Gr. 7	A 193 Gr. B7 / A 194 Gr. 2H	A 193 Gr. B7 / A 194 Gr. 2H
Bolt & Nut	A 193 Gr. B7 / A 194 Gr. 2H	A 193 Gr. B7 / A 194 Gr. 2H	A 193 Gr. B7 / A 194 Gr. 2H	A 193 Gr. B7 / A 194 Gr. 2H
Yoke Bolt & Nut	A 193 Gr. B7 / A 194 Gr. 2H	A 193 Gr. B7 / A 194 Gr. 2H	A 193 Gr. B7 / A 194 Gr. 2H	A 193 Gr. B7 / A 194 Gr. 2H
Segmental Ring	A 515 Gr. 70	A 182 Gr. F304	A 182 Gr. F304	A 182 Gr. F316
Handwheel	Carbon Steel	Carbon Steel	Carbon Steel	Carbon Steel

## FORGED GATE VALVE

Design : BS 5351 / API 602 / ISO 15761

Operation : Manual & Actuated (Diaphragm / Electric / Gear / Cylindrical)

End Connection	Size	Class
Flange End	15NB-50NB	150#- 1500#
Socket Weld / Screwed	15NB- 50NB	800#- 2500#

-  Air
-  Gas
-  Steam
-  Liquid
-  Chemical
-  High Temp.
-  Hazardous
-  Cryogenic

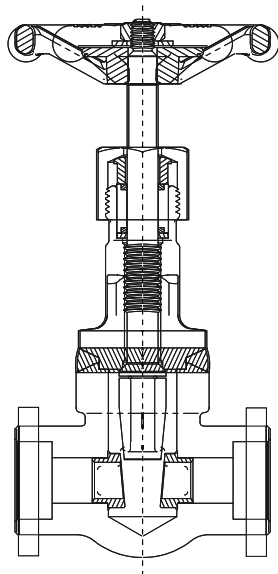

Description	Carbon Steel	Carbon Steel	Alloy Steel	Stainless Steel
Body	A 216 Gr. WCB	A 352 Gr. LCB	A 217 Gr. C5	A 351 Gr. CF8M
Bonnet	A 216 Gr. WCB	A 352 Gr. LCB	A 217 Gr. C5	A 351 Gr. CF8M
Wedge	A 216 Gr. WCB + Stellite	A 352 Gr.e LCB + Stellite	A 217 Gr. C5 + Stellite	A 351 Gr. CF8M + Stellite
Yoke	A 216 Gr. WCB	A 352 Gr. LCB	A 217 Gr. C5	A 351 Gr. CF8M
Stem	A 182 Gr. F6a	A 182 Gr. F304	A 182 Gr. F6a	A 182 Gr. F316
Seat Ring	A 105 + Stellite	A 182 Gr. F304 + Stellite	A 182 Gr. F6a + Stellite	A 182 Gr. F316 + Stellite
Stem Nut	B 148 / A 439 Gr	B 148 / A 439 Gr	B 148 / A 439 Gr	B 148 / A 439 Gr
Backseat	Stellite	Stellite	Stellite	Stellite
Gland	A 105	A 105	A 182 Gr. F6a	A 182 Gr. F316
Gland Flange	A 105	A 105	A 105	A 182 Gr. F304
Stem Packing	Graphite	Graphite	Graphite	Graphite
Gasket (Class 900)	Graphite or SS304L	Graphite or SS304L	Graphite or SS304L	Graphite or SS316L
Gasket (Class 1500)	Graphite or SS304L	Graphite or SS304L	Graphite or SS304L	Graphite or SS316L
Gasket (Class 2500)	Graphite or SS304L	Graphite or SS304L	Graphite or SS304L	Graphite or SS316L
Bonnet Bolt & Nut	A 193 Gr. B7 / A 194 Gr. 2H	A320 Gr. L7 / A194 Gr. 7	A 193 Gr. B7 / A 194 Gr. 2H	A 193 Gr. B7 / A 194 Gr. 2H
Bolt & Nut	A 193 Gr. B7 / A 194 Gr. 2H	A 193 Gr. B7 / A 194 Gr. 2H	A 193 Gr. B7 / A 194 Gr. 2H	A 193 Gr. B7 / A 194 Gr. 2H
Yoke Bolt & Nut	A 193 Gr. B7 / A 194 Gr. 2H	A 193 Gr. B7 / A 194 Gr. 2H	A 193 Gr. B7 / A 194 Gr. 2H	A 193 Gr. B7 / A 194 Gr. 2H
Segmental Ring	A 515 Gr. 70	A 182 Gr. F304	A 182 Gr. F304	A 182 Gr. F316
Handwheel	Carbon Steel	Carbon Steel	Carbon Steel	Carbon Steel

## LINED GATE VALVE

Lining Material: PTFE, PFA, FEP, PVDF, ETFE, Glass, Carbon PTFE

Design : DIN 3352 / API 6D / API 600

Operation : Manual & Actuated (Diaphragm / Electric / Gear / Cylindrical)

End Connection	Size	Class
Flange End	15NB-300NB	150#/PN16

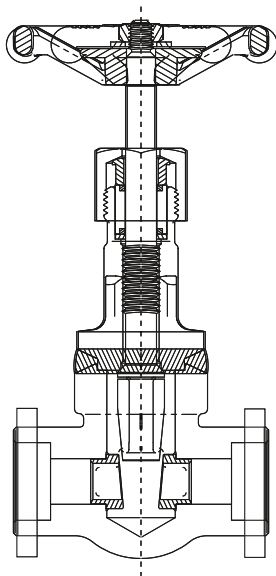

Chemical



Hazardous



Acid



Description	Carbon Steel	Carbon Steel	Alloy Steel	Stainless Steel
Body	A 216 Gr. WCB	A 352 Gr. LCB	A 217 Gr. C5	A 351 Gr. CF8M
Bonnet	A 216 Gr. WCB	A 352 Gr. LCB	A 217 Gr. C5	A 351 Gr. CF8M
Wedge	A 216 Gr. WCB + Stellite	A 352 Gr.e LCB + Stellite	A 217 Gr. C5 + Stellite	A 351 Gr. CF8M + Stellite
Yoke	A 216 Gr. WCB	A 352 Gr. LCB	A 217 Gr. C5	A 351 Gr. CF8M
Stem	A 182 Gr. F6a	A 182 Gr. F304	A 182 Gr. F6a	A 182 Gr. F316
Seat Ring	A 105 + Stellite	A 182 Gr. F304 + Stellite	A 182 Gr. F6a + Stellite	A 182 Gr. F316 + Stellite
Stem Nut	B 148 / A 439 Gr	B 148 / A 439 Gr	B 148 / A 439 Gr	B 148 / A 439 Gr
Backseat	Stellite	Stellite	Stellite	Stellite
Gland	A 105	A 105	A 182 Gr. F6a	A 182 Gr. F316
Gland Flange	A 105	A 105	A 105	A 182 Gr. F304
Stem Packing	Graphite	Graphite	Graphite	Graphite
Gasket (Class 900)	Graphite or SS304L	Graphite or SS304L	Graphite or SS304L	Graphite or SS316L
Gasket (Class 1500)	Graphite or SS304L	Graphite or SS304L	Graphite or SS304L	Graphite or SS316L
Gasket (Class 2500)	Graphite or SS304L	Graphite or SS304L	Graphite or SS304L	Graphite or SS316L
Bonnet Bolt & Nut	A 193 Gr. B7 / A 194 Gr. 2H	A320 Gr. L7 / A194 Gr. 7	A 193 Gr. B7 / A 194 Gr. 2H	A 193 Gr. B7 / A 194 Gr. 2H
Bolt & Nut	A 193 Gr. B7 / A 194 Gr. 2H	A 193 Gr. B7 / A 194 Gr. 2H	A 193 Gr. B7 / A 194 Gr. 2H	A 193 Gr. B7 / A 194 Gr. 2H
Yoke Bolt & Nut	A 193 Gr. B7 / A 194 Gr. 2H	A 193 Gr. B7 / A 194 Gr. 2H	A 193 Gr. B7 / A 194 Gr. 2H	A 193 Gr. B7 / A 194 Gr. 2H
Segmental Ring	A 515 Gr. 70	A 182 Gr. F304	A 182 Gr. F304	A 182 Gr. F316
Handwheel	Carbon Steel	Carbon Steel	Carbon Steel	Carbon Steel

# FRETURE

EMISSION FREE PROCESS

## CLIENTELE



# FRETURE TECHNO PVT. LTD.

 Alpack Comp, Milind Nagar  
Bhandup (W) Mumbai 400 078

 [www.freture.com](http://www.freture.com)  
 +91 75066 82777  
 [sales@freture.com](mailto:sales@freture.com)